

elproLOG SUITE

Overview elproLOG software system



Central Monitoring System



Measurement

- Precise and reliable measurement of temperature, relative humidity, pressure differential and other physical values
- Comprehensive assortment of sensors and accessories for various applications



Storage

- State-of-the-art datalogger technology
- Redundancy: Data storage even if the network connection or power fails

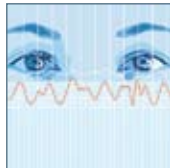

Online-Monitoring

- Real-time display of readings and alarms
- Secure data access from any PC in the network



Alarm

- Several alarm levels
- Audible and visual alarm functionality at your local computer
- Forwarding of alarms and warnings via e-mail, SMS or telephone



Analysis

- Clearly laid-out graphs and tables
- Multiple zooming and statistic functions
- MKT (Mean Kinetic Temperature) and Arrhenius calculation



Reporting

- Tools for commenting and marking data
- Complete reports in PDF format directly from the elproLOG software
- Data and graph export function (Excel® format*) and the possibility of saving data extracts

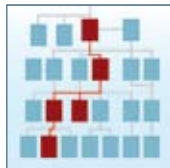

Traceability

- Audit trail functionality for gapless traceability
- Automatic storage of every operation and event with information about the event, user, date and time



Archiving

- Automatic, periodic download of datalogger data (Autosave)
- Automatically created audit trail for every data file during archiving



Service

- Professional maintenance and calibration services customized to your requirements
- Qualified staff that perform complete IQ/OQ tests and protocols for your datalogging system on site

elproLOG ANALYZE | ANALYZE QLS

PAGE 4



Base licence Part No. 2338-CDV



Base licence Part No. 2335-BL

elproLOG ANALYZE:

- ELPRO datalogger configuration
- Measured data storage
- Statistical data: min/max, mean value, standard deviation, variance
- MKT (Mean Kinetic Temperature), Arrhenius calculation
- Tools for commenting and marking data
- Complete reports in PDF format directly from software

elproLOG ANALYZE QLS

includes all ANALYZE software functions and implements numerous important tools to facilitate your work in qualified environments:

- Automatic audit trail creation at data readout

elproLOG MONITOR

PAGE 8



Base licence Part No. 2330-BL

- Real-time display of readings and alarms
- Alarm and warning notification
- Audible and visual alarm functionality at local computer
- Forwarding of alarms and warnings via e-mail, telephone, SMS/Fax
- Alarm acknowledge functions
- Automatic, periodic download of data (Autosave)
- Self-monitoring for highest system security

elproLOG MONITOR WebAccess

PAGE 10



Base licence Part No. 3560

- Secure and password-protected access to your information – from any PC anywhere in the world
- Customizable user interface
- Display of data on facility floor plans or photos
- Clearly laid-out graphs and tables
- Able to view data with standard Internet browser, no additional software installation required on client PC

elproLOG EVENT

PAGE 12



Base licence Part No. 2331-BL

- Central audit trail for all ELPRO software components (elproLOG MONITOR, elproLOG ANALYZE, ANALYZE QLS)
- Every entry stored with information about the event, user, date and time
- Data stored in a tamper-proof database

elproLOG USER

PAGE 14



Base licence Part No. 2332-BL

- User Management Software for the elproLOG SUITE software system
- Multiple groups of users with freely configurable access rights
- Comprehensive security features for user account management

elproLOG CONFIG

PAGE 14

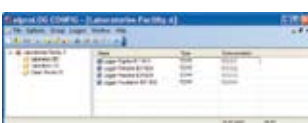

- elproLOG CONFIG is included with elproLOG ANALYZE/QLS and elproLOG MONITOR.
- Configuration and testing of the datalogger network
- Assignment of clear text names to sensors and digital inputs
- Setup of warning level for every sensor
- Deactivation of inputs for maintenance purposes
- Automatic reports with information about the datalogger network structure

elproLOG ANALYZE

SOFTWARE PACKAGE FOR EVALUATION OF DATA BY ALL ELPRO DATALOGGERS

elproLOG ANALYZE – FOR EVALUATION OF YOUR MEASURED DATA

The elproLOG ANALYZE software package provides all the functions you require for simple and efficient work with dataloggers and measured data.

elproLOG ANALYZE is the result of many years of industry-oriented and GMP-conforming software development. Making your work with our dataloggers as easy and efficient as possible is always the focus of our development.

One software package for all ELPRO dataloggers

In addition to the data analysis and reporting functions, elproLOG ANALYZE is the only tool you need to configure your ELPRO datalogger; the software recognizes all generations of instruments automatically.

Documentation accomplished in three steps

Use elproLOG ANALYZE and experience how you can use your measured data to create complete and clearly formatted reports in three easy steps:

1. Readout:

Easy instrument configuring and fast, problem-free readout of recorded data.

2. Analyze:

Broad choice of view formats and statistic functions to support analysis of measured data.

3. Report:

Creation of informative clearly laid-out documentation. The installed PDF function generates complete reports from the measured data in the universal Adobe® PDF format.

Adobe® is a registered trademark of Adobe Systems Incorporated.



1 READOUT

elproLOG ANALYZE is the ELPRO software for simple and user-friendly communication with dataloggers. Any ELPRO datalogger you use is recognized automatically by the elproLOG ANALYZE software.

The software is also capable of opening and displaying PDF files generated with the Libero PDF Logger® and the contained raw data. These features make instrument configuration and data readout effortless.

- Configuration of ELPRO dataloggers
- Saving of measured data
- Analysis of Libero PDF files



2 ANALYZE

elproLOG ANALYZE offers a multitude of functions for analyzing recorded data. Choose between table and graphics displays for your data and use the zoom and marking functions for easy navigation through the logged data points.

In a matter of seconds, elproLOG ANALYZE can analyze complex graphs to provide the exact information that is important to you.

- Clearly laid-out graphs and tables
- Multiple zooming functions
- Statistical data: min/max, mean value, standard deviation, variance
- Dew point calculation
- Histogram representation
- Graph superimposing
- MKT (Mean Kinetic Temperature), Arrhenius calculation

Tabular display with color-marking to highlight measured values outside alarm limits

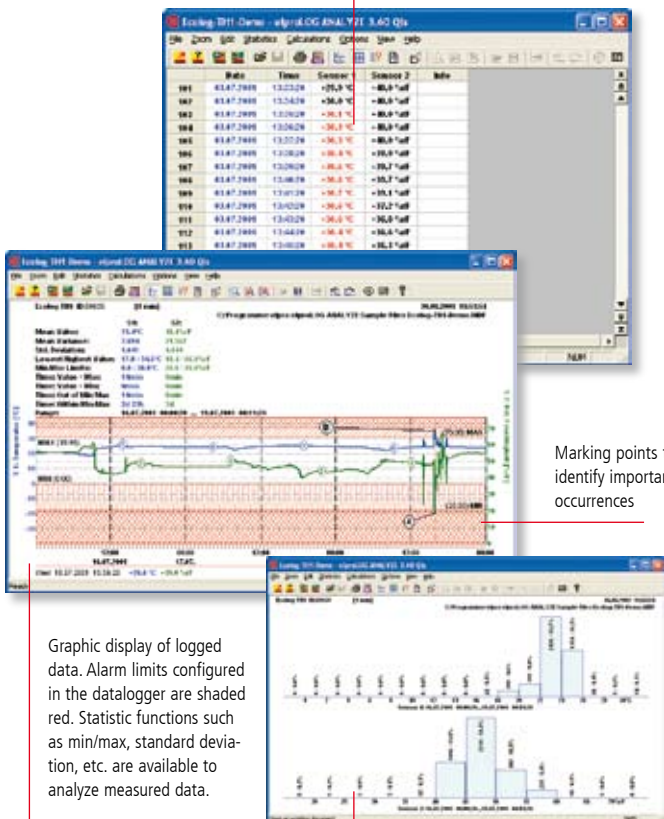

Graphic display of logged data. Alarm limits configured in the datalogger are shaded red. Statistic functions such as min/max, standard deviation, etc. are available to analyze measured data.

Histogram representation of logged data

3 REPORT

Create comprehensive reports directly from elproLOG ANALYZE. The software allows you to append comments and notes and it is possible to mark the most important occurrences in the data. Use the installed PDF printer and, at the press of a button, you can generate documentation printouts with all the relevant information.

- Tools for commenting and marking data
- Complete reports in PDF format directly from elproLOG ANALYZE
- Possibility of saving data extracts
- Data and graph export function (Excel format)
- E-mail: Send data file via e-mail to receiver
- Hardcopy of all screens with print preview
- Status printout with information about datalogger
- Own company logo on all documents

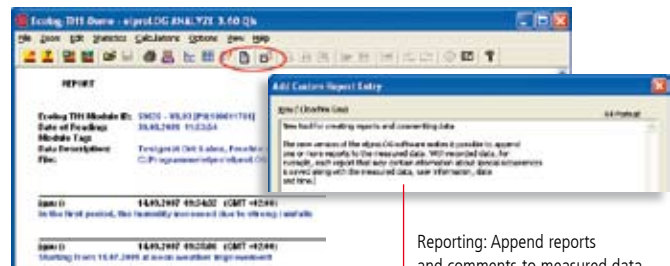

Reporting: Append reports and comments to measured data

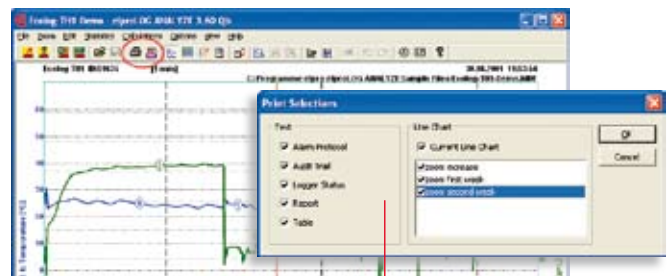

Reporting: Direct printout of complete, multi-page reports, either directly into a PDF file or to your printer



Report with logo, graphics, marking points and statistics

elproLOG ANALYZE QLS

SOFTWARE PACKAGE FOR QUALIFIED SYSTEMS

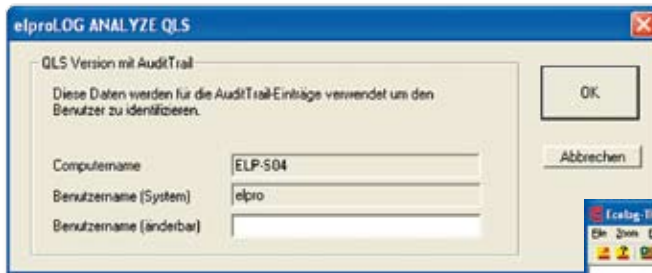

A personal logon is performed at software startup.

All activities related to measured data are recorded in an audit trail.

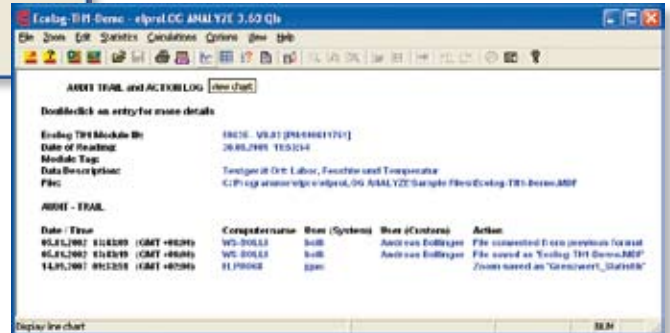

ELPRO QLS QUALIFIED LOGGER SYSTEM



elproLOG ANALYZE QLS is the software package for qualified systems. This software helps you comply with the provisions of FDA 21 CFR Part 11, GMP, GAMP 5, GLP and Annex 11. The detailed validation manual contains IQ/OQ templates for easy software qualification.

elproLOG ANALYZE QLS includes all ANALYZE software functions and implements numerous important tools to facilitate your work in qualified environments. For ELPRO, as for many of our customers, safety and traceability in processes are central issues. Consequently, all ELPRO development complies with GMP specifications. This guarantees the quality and security you expect.

SECURITY FOR VALIDATED ENVIRONMENTS

- Software validation with ELPRO validation manual for 21 CFR Part 820
- Compact coded data file
- Compliance with FDA 21 CFR Part 11
- Forgery and manipulation protection – coded data transfer from logger to PC
- Automatic audit trail created at data readout
- Multipath transmission with check sums

AUDIT TRAIL

An audit trail is created automatically during data readout from the datalogger. All data-relevant transactions are recorded. Each file generated in this manner is an individual and completely safe document. The raw data (source file) cannot be manipulated. The audit trail is attached to the file that contains the measured values. The resulting electronic document has the advantage of being a completely independent record that can easily be e-mailed or printed at any time.

Advantages of an audit trail solution

- All requirements for electronic documents are in compliance with FDA 21 CFR Part 11.
- You can send the files from any PC.
- Security: The elproLOG ANALYZE QLS software is required to open the generated data files. For this reason, the audit trail function guarantees a complete data security solution.
- Clear, understandable audit trail documents all previous modifications.
- Audit trail cannot be removed from the source file (*.mdf).

SYSTEM REQUIREMENTS

Operating system: Windows 2000, Windows XP, Windows Vista	Memory: 512 MB RAM
PC requirements: Pentium 1.5 GHz	Free memory on HD: 50 MB
	Screen resolution: Min. 800x600 pixels
	Interface: RS232, USB or LAN

Windows® is a registered trademark of Microsoft Corporation in the United States and other countries.

COMPLETE QUALIFICATION DOCUMENTATION

elproLOG ANALYZE QLS is not just the result of many years of industry-oriented software development; it's a complete qualification solution. In combination with the software package, you receive a complete set of qualification documentation that passes on our know-how in the form of guidelines and templates for your qualification process. We take you step by step through the individual stages of the qualification process, saving you time and money.

Qualification documentation for elproLOG ANALYZE QLS

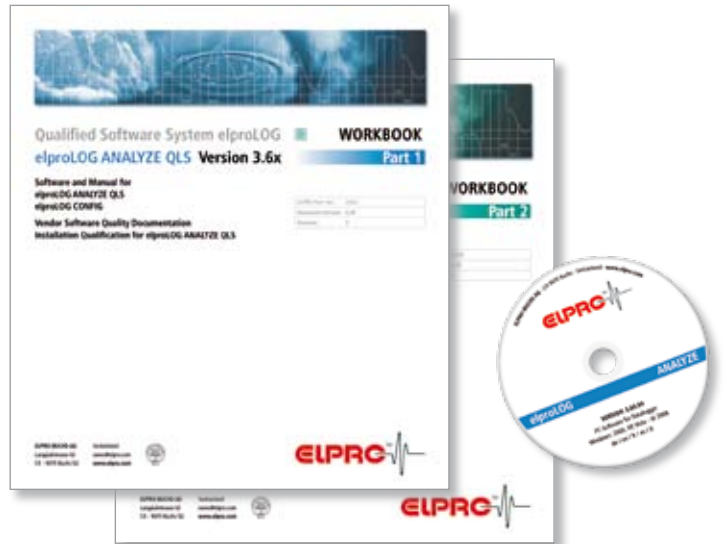

Software installation

elproLOG ANALYZE and ANALYZE QLS software can be implemented as a stand-alone application or as a network-based solution. It is installed locally on each computer, either from a CD or via the network. Running the software directly from the CD or network drive without performing an installation is not possible.

An additional licence is required for each QLS version installation. It is possible to define a working directory for access to shared data.

QUALIFICATION DOCUMENTS – SUMMARY

With elproLOG ANALYZE QLS, you receive two binders of valuable qualification documents for your ELPRO datalogging system.

How to use

Our goal is to make the qualification work as easy and smooth as possible for you. Therefore, we included detailed checklists that guide you step by step through the qualification procedure.

Vendor software quality

The ELPRO QLS Workbook includes important information about the GMP-compliant product development process at ELPRO. It also includes a declaration of compliance to FDA 21 CFR Part 11 and a copy of our company's ISO 9001 certificate.

Installation Qualification

The Installation Qualification (IQ) templates in the workbook ensure easy step-by-step qualification. For additional assistance, we included a complete IQ, referred to as vendor qualification, on yellow pages in the workbook.

Operation Qualification

During the Operation Qualification (OQ) all relevant functions of the elproLOG ANALYZE QLS software are tested, from data read-out to report generation. All qualification steps are listed in clearly laid-out forms to help you perform the qualification. And to simplify your work, we included a complete ELPRO vendor qualification.

elproLOG MONITOR

SOFTWARE FOR MONITORING AND ALARM



REAL-TIME ACCESS TO YOUR DATA

No more moving from datalogger to datalogger to monitor and download information. Review and analyze recorded temperature, humidity, CO₂, particles or pressure differential data from any PC in your lab. elproLOG MONITOR provides real-time access to all your data and helps you comply with FDA 21 CFR Part 11, GLP, GMP and GAMP 5.

Alarm conditions are red
Warnings are orange
Sensor and network errors are yellow
Deactivated inputs are gray

Sensor Name	Sensor Value	Sensor Unit
ULT Freezer 1 Laboratory A21	-25.2	°C
ULT Freezer 2 Laboratory A21	-19.8	°C
ULT Freezer 3 Laboratory A21	-26.0	°C
ULT Freezer 4 Laboratory A21	-50.2	°C
Differential Pressure Production Room 1	15.5	Pa
Differential Pressure Production Room 1	nul	
Differential Pressure Production Room 1	22.4	Pa
Differential Pressure Production Room 1	20.8	Pa
Rel. Humidity GMP Storage Floor B	38.5	%
Ambient Temperature GMP Storage Floor B	22.2	°C
Fridge 1 GMP Storage Floor B	-4.1	°C

FUNCTIONS

- Real-time display of readings and alarms
- Alarm and warning notifications
- Audible and visual alarm functionality at local computer
- Forwarding of alarms and warnings:
 - via e-mail
 - via automatic telephone dialing unit
 - to building management systems (with alarm interface)
 - via SMS
- Alarm acknowledgement functions
- Archiving: automatic, periodic download of datalogger data (Autosave)
- Self-monitoring for highest system security (with alarm interface)
- Audit trail for traceability of parameter changes and user actions
- Support of compliance with FDA 21 CFR Part 11 / GMP / GLP / GAMP 5 and Annex 11
- Comprehensive documentation for IQ/OQ

FUNCTIONALITY

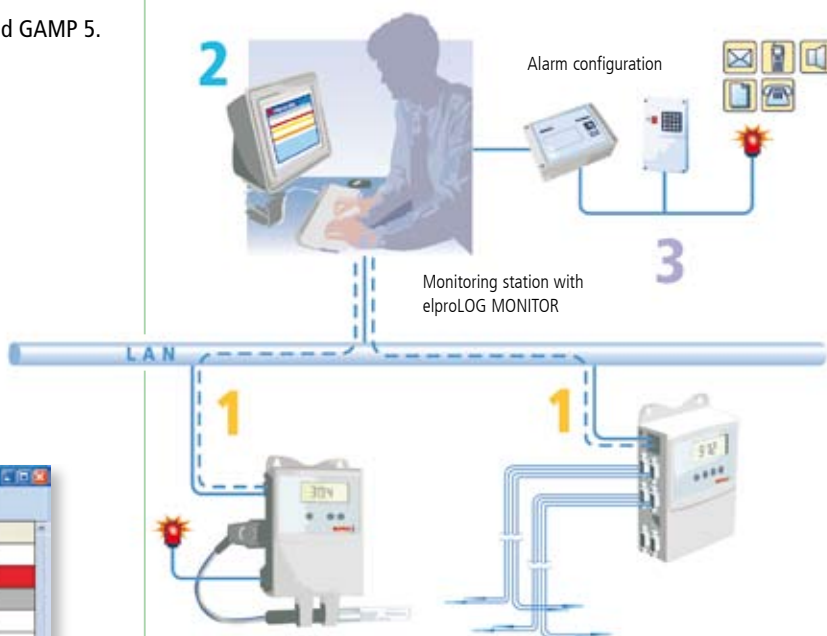

- 1 Readings and alarms are transferred in real-time over the LAN/Wireless LAN network. Within elproLOG MONITOR, all data is collected and processed.
- 2 elproLOG MONITOR displays all data points in real-time.
- 3 In the case of out-of-specification conditions, elproLOG MONITOR automatically sends alarms via e-mail or telephone.

LOGGING / AUDIT TRAIL

Date/Time PC	Date/Time Logger	Alarm Info	Sensor Name
2.4.2007 15:28	2.4.2007 15:28	Alarm Level exceeded	ULT Freezer 1 Lab 21
2.4.2007 16:02	2.4.2007 16:02	Alarm confirmed	ULT Freezer 1 Lab 21
2.4.2007 17:00	2.4.2007 17:00	Sensor Error	ULT Freezer 2 Lab 21
2.4.2007 17:01	2.4.2007 17:01	Alarm limit normal	ULT Freezer 1 Lab 21
2.4.2007 17:25	2.4.2007 17:25	no connection to Logger 5	
2.4.2007 17:30	2.4.2007 17:30	connection to logger 5 re-established	

All parameter changes and system events like alarms, warnings and acknowledgements are recorded automatically in the elproLOG EVENT* database to ensure traceability.

* If elproLOG EVENT is not available on the system, logging is done using a local log file.

ALARM FUNCTIONS

The system offers the highest security and various different alarm functions. From local alarms at the datalogger using an alarm flash to forwarding alarms using the alarm interface, the ELPRO Central Monitoring System ensures that you are notified should a problem occur.

ALARM LEVEL 1: LOCAL ALARM AT THE DATALOGGER

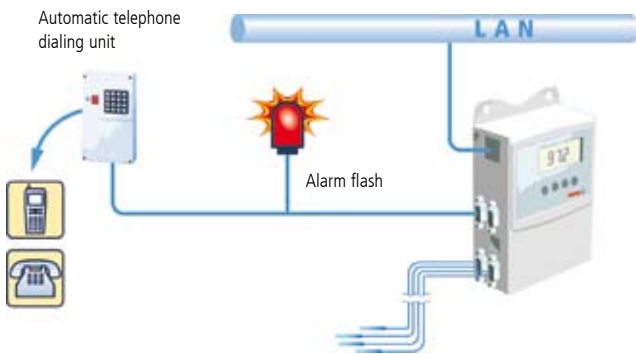

ECOLOG-NET dataloggers with alarm functions can be used to directly connect alarm devices, such as alarm flashes or automatic telephone dialing units.

ALARM LEVEL 2: CENTRAL ALARMING

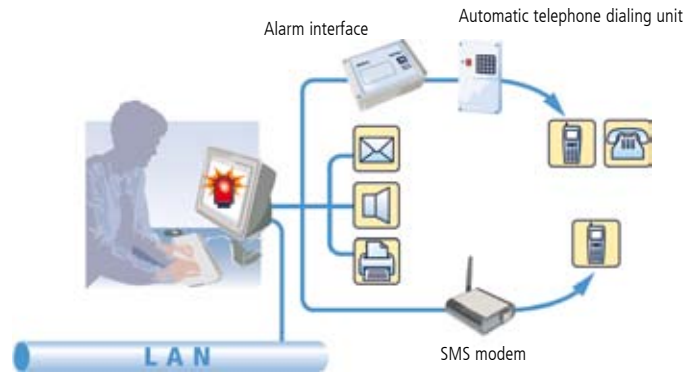

elproLOG MONITOR offers multiple ways to forward an alarm:

- Through e-mail
- By telephone (with alarm interface and automatic telephone dialing unit)
- To building management systems (with alarm interface)
- Through SMS (with SMS modem)

ALARM INTERFACE 2335-A

The alarm interface is connected to a USB port of the monitoring station.



FUNCTIONS

Alarm forwarding

For alarm forwarding, the alarm interface offers two dry change-over contacts.

Alarm repetition, alarm delay

The alarm interface can be configured to continuously repeat alarms or to send the alarms with a time delay.

Watchdog functionality

For highest security, the alarm interface offers a watchdog function to self-monitor the system.

SMS MODEM 2356-A

The SMS modem is connected to a USB port of the monitoring station.



FUNCTIONS

In the case of an out-of-specification condition, the SMS modem automatically sends alarm text messages to one or more recipients. The modem can be configured to continuously repeat messages for active alarms.

ALARM ACKNOWLEDGEMENT

elproLOG MONITOR Alarm					
Date/Time PC	Date/Time Logger	Alarm Info	Sensor Name	Confirmed by	Confirmation
2.4.2007 15:28	2.4.2007 15:28	Alarm Level exceeded	ULT Freezer 1 Lab 21	PN / 2.4.2007 16:02	
2.4.2007 17:00	2.4.2007 17:00	Sensor Error	ULT Freezer 2 Lab 21		<input type="button" value="Confirm"/>
2.4.2007 17:25	2.4.2007 17:25	no connection to Logger 5			<input type="button" value="Confirm"/>

With elproLOG MONITOR, each alarm can be acknowledged separately.

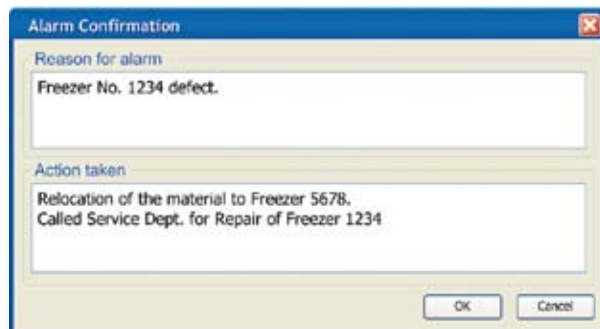

The software allows detailed commenting of every alarm event. All information is automatically stored in the elproLOG EVENT* database.

elproLOG MONITOR WebAccess

DATA VISUALIZATION VIA INTERNET

DATA ACCESS VIA INTERNET

With elproLOG MONITOR WebAccess, you can securely access your measurement data from any PC in the world. You can review and analyze recorded temperature, humidity, CO₂, particles or pressure differential data by using your Internet browser. No additional software is required on your PC.

And of course, access to your data can be password protected, so security and confidentiality are ensured at all times.

FUNCTIONALITY

- 1 Data recorded by the dataloggers is transferred periodically to the elproLOG MONITOR software.
- 2 All new data is transferred automatically via FTP or internal network to a web server running elproLOG MONITOR WebAccess.
- 3 Transferred data can be accessed from any PC using an Internet browser.

FUNCTIONS

- Secure and password-protected access to your information – from any PC anywhere in the world
- Real-time display of data on facility floor plans or photos
- Customizable user interface
- Clearly laid-out graphs and tables
- Able to view data with standard Internet browser, no additional software installation required on client PC

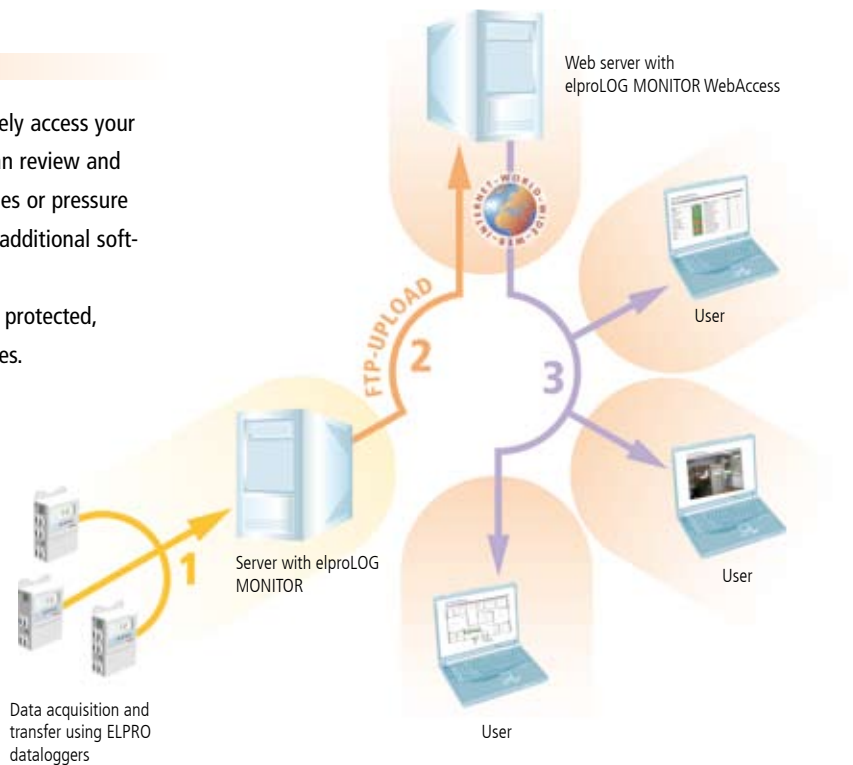

SYSTEM REQUIREMENTS

For elproLOG MONITOR WebAccess, a web server is required. Alternatively, ELPRO provides a service for hosting your data in a high-security data center in Switzerland.

OPTION 1

Hosting by customer
Part No. 3560

Mode of operation

- Scripts required for elproLOG MONITOR WebAccess are installed on your web server.
- Recorded data is transferred to the web server using your internal network or FTP.
- To transfer data via FTP, elproLOG MONITOR WebAccess includes the elproLOG MONITOR WebUpload utility.
- You can access data on the web server by using a standard Internet browser.

Software package

- PHP-Scripts for viewing data online
- elproLOG WebUpload to transmit data to the server

System requirements

- Web server with PHP 5 and FTP access
- Possibility of changing file authorizations
- Password-protected folders, if access protection is desired
- Knowledge of web server administration
- Manual installation of the software (no setup, no Windows® program)

OPTION 2

Hosting by ELPRO
Part No. 3550 (Starter package)

Mode of operation

- ELPRO hosts the data; the web center is in a high-security data center in Switzerland.
- Recorded data is transferred to the web server in Switzerland via FTP using the elproLOG MONITOR WebUpload utility.
- You can access data on the web server by using a standard Internet browser.

Software package

- elproLOG WebUpload to transmit data to the server

DATA VIEWING

Data displayed on facility floor plans or photos

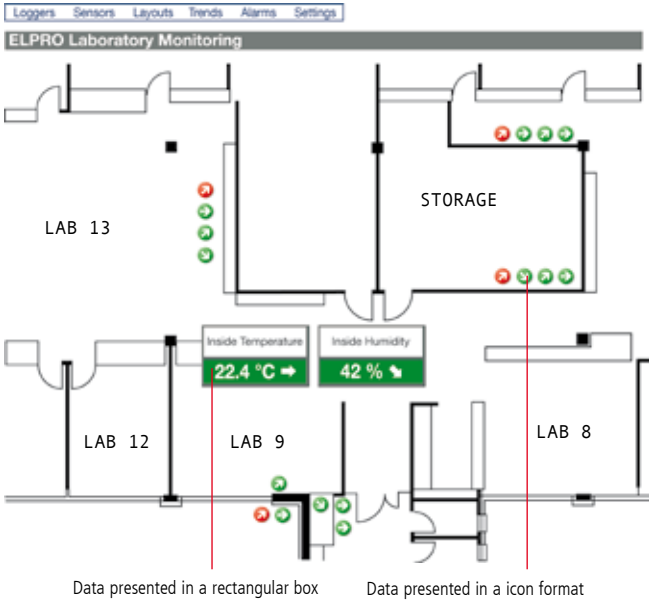

- When displaying data, any plan or photo can be used as the background.
- Every input can be displayed either as a rectangular box or as an icon.
- Inputs in alarm condition are displayed red and an arrow indicates the current trend of the signal.
- You can review and analyze detailed data of each measuring point by simply clicking on the icon.

All the information at your fingertips

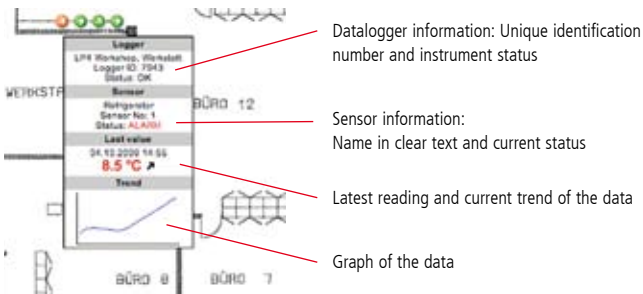

With elproLOG MONITOR WebAccess you receive all the important information from every measuring point in a matter of seconds. When you move the «mouse» over an input, a popup window shows status information and a real-time chart of data.

Real-time graphs and tables

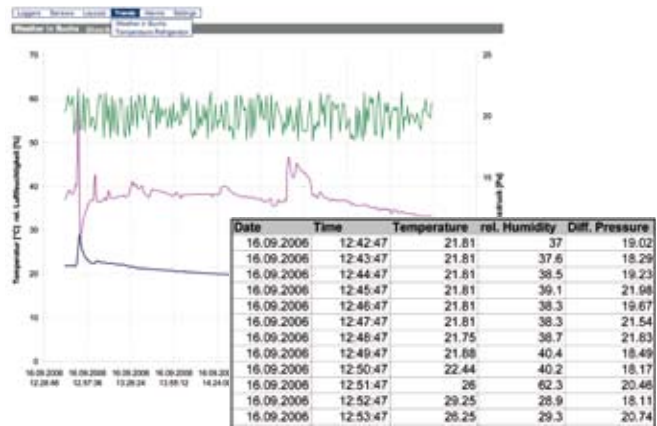

elproLOG MONITOR WebAccess allows you to display your data in real-time as a graph or as a table. Related signals (e.g., signals from a clean room) can be combined as a chart group.

Sensor lists

Sensor	Value	Logger	Logger ID	Sensor No.
Ambient	28.8 °C	LPH Workshop, Werkstatt	7943	4
Ambient Pressure	997.7 mbar	LAB Climate, Klima	8331	7
Engineer	13.30 km/h	LAB Climate, Klima	8331	9
CO2	485.4 ppm	LAB Climate, Klima	8331	8
Door Refrigerator	closed	LPH Workshop, Werkstatt	7943	01
Inside Humidity	43 %	LAB Climate, Klima	8331	6
Inside Temperature	22.4 °C	LAB Climate, Klima	8331	3
Outside Humidity	82.1 %	LAB Climate, Klima	8331	2
Outside Temperature	19.8 °C	LAB Climate, Klima	8331	1
Oven	96.3 °C	LPH Workshop, Werkstatt	7943	2
Refrigerator	8.5 °C	LPH Workshop, Werkstatt	7943	1
Server	33.4 °C	LPH Workshop, Werkstatt	7943	3
Velocity	5.127 m/s	LAB Climate, Klima	8331	5

Different signals can be grouped together in sensor lists. This enables you to set up the WebAccess configuration according to your requirements (e.g., a sensor list for every laboratory).

Alarms and reports



All active alarms and warnings of the system are displayed in elproLOG MONITOR WebAccess on a single page. With a «mouse» click on the rectangle, you automatically see the chart or table display of the measuring point in alarm status. In addition, a protocol is available for detailed analysis of the alarm history.

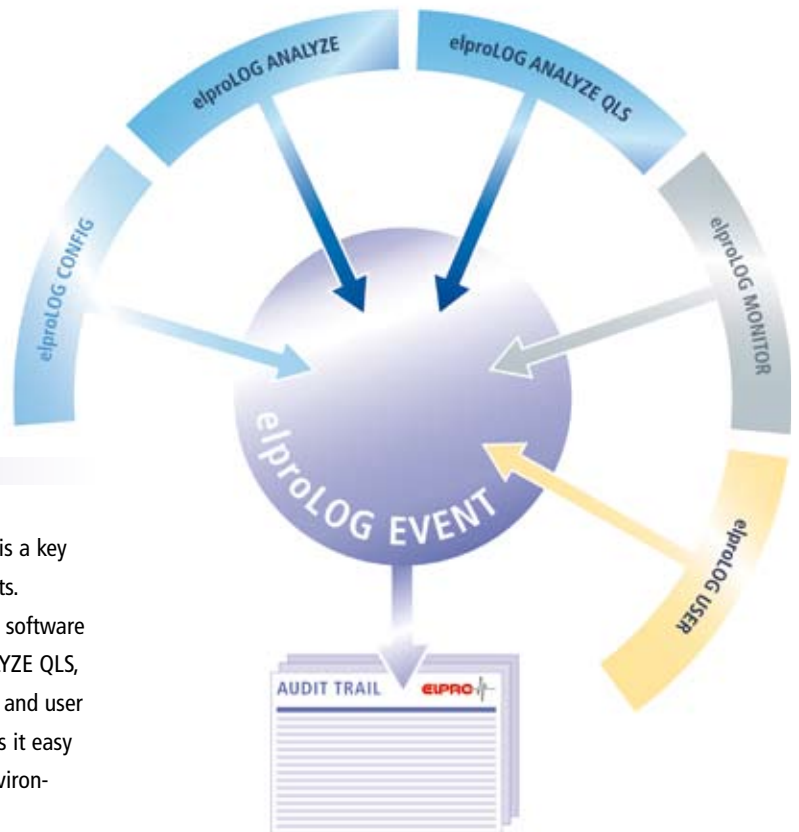

TRACEABILITY MADE EASY

Ensuring traceability of parameter changes and user actions is a key aspect for monitoring systems used in regulated environments. elproLOG EVENT generates a central audit trail for all ELPRO software components (elproLOG MONITOR, elproLOG ANALYZE, ANALYZE QLS, elproLOG CONFIG). All GMP-relevant changes to parameters and user actions are recorded by the software. elproLOG EVENT makes it easy to answer the core question when operating in regulated environments: Who operated what and when?

FUNCTIONS

- Every entry is stored with information about the event, user, date and time.
- Data is stored in a tamper-proof database.
- elproLOG EVENT supports compliance with FDA 21 CFR Part 11 / GMP / GLP / GAMP 5 and Annex 11.
- elproLOG EVENT includes comprehensive documentation for IQ/OQs.

EVENT ANALYSIS AND REPORTING

Data recorded by elproLOG EVENT is displayed in a clearly laid-out table. Data can be filtered to display only events from a specific period or from a certain user.

Event Type	Date/Time	Priority	Event	Application	User	Hostname
Alarm	2.4.2007 15:28	High	Alarm occurred	elproLOG MONITOR	Alex Myler	ELPRO_01
Alarm	2.4.2007 16:02	High	Alarm acknowledged	elproLOG MONITOR	Alex Myler	ELPRO_01
Information	2.4.2007 17:00	Normal	Program settings changed	elproLOG MONITOR	Alex Myler	ELPRO_01
Information	2.4.2007 17:01	Normal	Application started	elproLOG ANALYZE QLS	Sarah Myler	ELPRO_06
Information	2.4.2007 17:25	Normal	Datalogger setup changed	elproLOG ANALYZE QLS	Sarah Myler	ELPRO_06
Information	2.4.2007 17:30	Normal	Autosave process started/scheduled	elproLOG MONITOR	Alex Myler	ELPRO_01
Event Details						
Logger ID	65535					
Logger Name	Freezer Room 3					
Sensor No.	2					
Sensor Name	Freezer 268					
Logger Time	2.4.2007 16:02					
Reason for alarm	Freezer 268 defect.					
Action taken	Relocation of the material to Freezer 269. Called Service Dept. for repair of Freezer 268					
Priority	Priority					

FUNCTIONALITY

elproLOG EVENT operates completely in the background and ensures gapless traceability. The following example shows how elproLOG EVENT operates.

Event Type	Date/Time	Priority	Event	Application	User	Hostname
Information	13.3.2008 14:02	Low	Application started	elproLOG ANALYZE QLS	Sarah Myer	ELPRO_56
Information	13.3.2008 14:03	Normal	Datalogger readout	elproLOG ANALYZE QLS	Sarah Myer	ELPRO_56
Information	13.3.2008 14:06	Normal	File saved	elproLOG ANALYZE QLS	Sarah Myer	ELPRO_56
Information	13.3.2008 14:10	Normal	Datalogger setup changed	elproLOG ANALYZE QLS	Sarah Myer	ELPRO_56
Information	13.3.2008 14:15	Normal	Datalogger setup changed	elproLOG ANALYZE QLS	Sarah Myer	ELPRO_56
Information	13.3.2008 17:30	Normal	Alarm parameters changed	elproLOG ANALYZE QLS	Sarah Myer	ELPRO_56
Alarm	14.3.2008 22:15	High	Alarm occurred	elproLOG MONITOR		ELPRO_01
Alarm	14.3.2008 22:30	High	Alarm acknowledged	elproLOG MONITOR	Alex Miller	ELPRO_01
Alarm	14.3.2008 22:51	High	Alarm not longer active	elproLOG MONITOR		ELPRO_01

1 13 MAR 2008 14:02

A laboratory worker is assigned to reconfigure a datalogger. She runs the elproLOG ANALYZE QLS software and performs the steps required:

1. Readout of the datalogger
2. Storage of the recorded data
3. Re-configuration of the datalogger
4. Re-configuration of the alarm levels

2 13 MAR 2008 22:15

Due to a door left open inadvertently, the temperature of a freezer rises above the specified alarm level. The data-logging system issues an alarm.

3 13 MAR 2008 22:30

A laboratory worker closes the freezer and confirms the alarm using elproLOG MONITOR.

4 13 MAR 2008 22:51

The freezer temperature is back to normal.

广州虹科电子科技有限公司 广州市五山华南理工大学国家科技园 2 号楼 504-505 室 (510640)

电话 : 020-3874 3030; 3874 3032 e-mail: sales@hkaco.com 网站: www.hkaco.com

elproLOG USER

CONFIGURATION OF THE DATALOGGER NETWORK

SECURE AND FLEXIBLE ACCESS CONTROL

Controlling access to a software system is an important aspect when using a monitoring system in a GxP environment. elproLOG USER is a comprehensive user management tool for all ELPRO software components (elproLOG MONITOR, elproLOG ANALYZE, ANALYZE QLS and elproLOG CONFIG).

FUNCTIONS

- Is the User Management Software for the elproLOG SUITE software system
- Allows access rights to be configured freely to ensure that only authorized users are able to access records and make changes to the system configuration
- Provides comprehensive security features for user account management
- Supports compliance with FDA 21 CFR Part 11 / GMP / GLP / GAMP 5 and Annex 11
- Includes comprehensive documentation for IQ/OQ

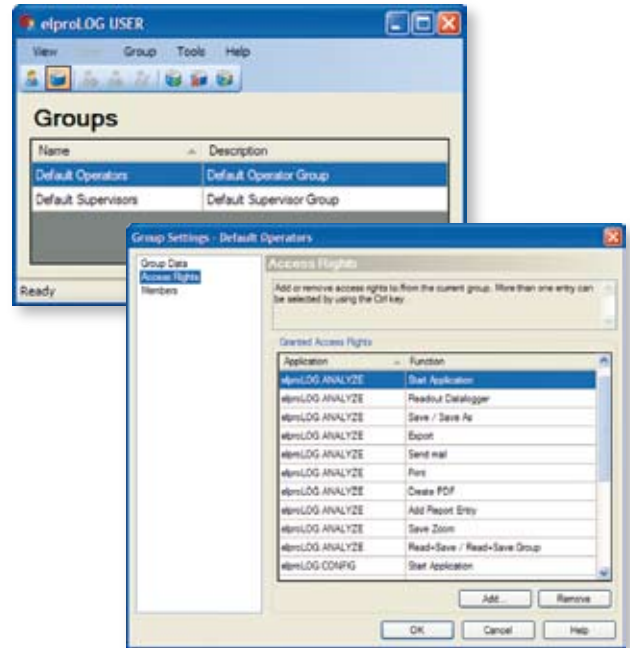

elproLOG USER
Base licence Part No. 2332-BL

elproLOG CONFIG

CONFIGURATION OF THE DATALOGGER NETWORK

SYSTEM CONFIGURATION

elproLOG CONFIG is the utility used to configure your ELPRO datalogger network. The software is included in the elproLOG ANALYZE and elproLOG MONITOR software.

FUNCTIONS

- Configuration and test of the datalogger network
- Assignment of clear text names to sensors and digital inputs
- Setup of warning level for every sensor
- Deactivation of inputs for maintenance purposes
- Scheduler for automatic activation / deactivation of sensors (e.g. for day / night operation)
- Automatic reports with information about the datalogger network structure



广州虹科电子科技有限公司 广州市五山华南理工大学国家科技园 2 号楼 504-505 室 (510640)

elproLOG SUITE

FUNCTIONAL OVERVIEW



	ANALYZE	ANALYZE QLS	MONITOR	MONITOR WebAccess	EVENT	USER	CONFIG
Datalogger operations							
Datalogger configuration	✓	✓					
Datalogger readout	✓	✓					
Measuring data							
Detailed data analysis	✓	✓					
Zooming, marking lines	✓	✓					
Graph superimposing	✓	✓					
Report generation in PDF format	✓	✓					
Export of data and charts	✓	✓					
MKT, Arrhenius	✓	✓					
Statistical calculations	✓	✓					
Dewpoint calculation	✓	✓					
Archiving: automatic data download from datalogger (Autosave)		✓					
Clearly laid-out graphs and tables for offline analysis	✓	✓					
Monitoring and alarm							
Clearly laid-out graphs and tables for real-time analysis			✓				
Warning limits			✓				
Audible and visual alarm on local computer			✓				
Output of alarms to printer			✓				
Alarm forwarding (e-mail, phone)			✓				
Watchdog functionality (with alarm interface)			✓				
Alarm acknowledgement with commenting function			✓				
Data and alarm viewing via Internet				✓			
Data display on facility floor plans or photos				✓			
Real-time graphs and tables				✓			
Security / compliance							
Audit trail for events and user actions (with elproLOG EVENT)	✓	✓	✓		✓	✓	✓
Measuring data with audit trail		✓					
Compliance support for FDA 21 CFR Part 11 / GMP / GLP / GAMP 5 and Annex 11		✓	✓	(✓)*	✓	✓	
Comprehensive documentation for IQ/OQ		✓	✓	✓	✓	✓	
Access control and comprehensive security functions (with elproLOG USER)	✓	✓	✓		✓	✓	✓
Configuration and setup							
Configuration and test of datalogger network							✓
Assignment of names to measuring points and digital inputs							✓
Deactivation of inputs for maintenance purposes							✓
Automatic reporting of datalogger network configuration							✓
Datalogger / Sensor scheduler							✓
Part numbers							
Basic program Base licence	2338-CDV	2335-BL	2330-BL	3560	2331-BL	2332-BL	–
Update version basic program Base licence	2338-CDU	2335-BLU	2330-BLU	–	2331-BLU	2332-BLU	–
Follow licence	–	2335-FLU	2330-FL	–	2331-FL	2332-FL	–
Update version follow licence	–	–	2330-FLU	–	2331-FLU	2332-FLU	–

* elproLOG MONITOR WebAccess is a read-only view of the data.
Therefore, the software is not subject to regulations according FDA 21 CFR Part 11.



elproLOG SOFTWARE BUNDLES

Software starter package for online monitoring and data analysis:

- Part No. 3571 **elproLOG START QLS**
- Art. Nr. 2335-FL
 - Art. Nr. 2330-FL

Software package for the use in validated areas:

- Part No. 3573 **elproLOG Standard QLS**
- Part No. 2335-BL elproLOG ANALYZE QLS Base Licence
 - Part No. 2330-BL elproLOG MONITOR Base Licence
 - Part No. 2331-BL elproLOG EVENT Base Licence
 - Part No. 2333 Documents for datalogger IQ/OQ
- Part No. 3573-WA **elproLOG Standard QLS with WebAccess**
- Part No. 2335-BL elproLOG ANALYZE QLS Base Licence
 - Part No. 2330-BL elproLOG MONITOR Base Licence
 - Part No. 2331-BL elproLOG EVENT Base Licence
 - Part No. 3560 elproLOG MONITOR WebAccess
 - Part No. 2333 Documents for datalogger IQ/OQ
- Part No. 3574 **elproLOG Premium QLS**
- Part No. 2335-BL elproLOG ANALYZE QLS Base Licence
 - Part No. 2330-BL elproLOG MONITOR Base Licence
 - Part No. 2331-BL elproLOG EVENT Base Licence
 - Part No. 2332-BL elproLOG USER Base Licence
 - Part No. 2333 Documents for datalogger IQ/OQ
- Part No. 3574-WA **elproLOG Premium QLS with WebAccess**
- Part No. 2335-BL elproLOG ANALYZE QLS Base Licence
 - Part No. 2330-BL elproLOG MONITOR Base Licence
 - Part No. 2331-BL elproLOG EVENT Base Licence
 - Part No. 2332-BL elproLOG USER Base Licence
 - Part No. 3560 elproLOG MONITOR WebAccess
 - Part No. 2333 Documents for datalogger IQ/OQ

ELPRO-BUCHS AG

(head office)

CH 9470 Buchs SG

Switzerland

web www.elpro.com



ELPRO Services, Inc.

210 Millcreek Road

Marietta, OH 45750

USA

T 740 568.9900

F 740 569.9399

e usa@elpro.com

web www.elpro.com

DIRECTIVES & STANDARDS

ISO 9001: 2000
SGS certificate no. CH98/0013

ATEX
Approval for EX protection zone 1
EN 60079-0:2006
EN 60079-11:2007, EN 1127-1:2007

CE
EN 61000-6-2:2006 and
EN 61000-6-4:2006

EN12830/EN13485/EN13486
Temperature recorder for
transport, storage and distribution
of foodstuffs

GZ1480
Exceptional approval for calibration
GZ1480/2000 from 10.4.2000, BEV,
Austria

INTEGRATED REGULATIONS & RECOMMENDATIONS

GMP/GLP/GAMP 5
Software validation in accordance with
21 CFR Part 820, Electronic Records
21 CFR Part 11, 21 CFR Part 210/211,
21 CFR Part 110, 21 CFR Part 58, Annex 11

EG/EU
Regulation (EC) 37/2005
Directive 2002/95/EC (RoHS)

HACCP
Hazard Analysis Critical Control Points

SERVICE & QUALITY

- ISO 9001 quality system
- Vendor and internal audits
- Expert systems
- Own production and development
- Own calibration laboratory
- Calibration according to all standards
- Customer calibration service
- Modern facilities
- Datalogger service since 1989
- Repair service
- Qualification service (IQ/OQ)
- Temperature mapping service
- Worldwide distributors
- Return of ELPRO instruments and batteries for eco-friendly disposal

ELPRO UK Ltd

Unit 1, Allen's Yard

Nyton Road

Aldingbourne, Chichester

West Sussex PO20 3UA

United Kingdom

T +44 (0)1243 544 545

F +44 (0)1243 210 132

e uk@elpro.com

web www.elpro.com